

Art. Nr. 345999

1/5

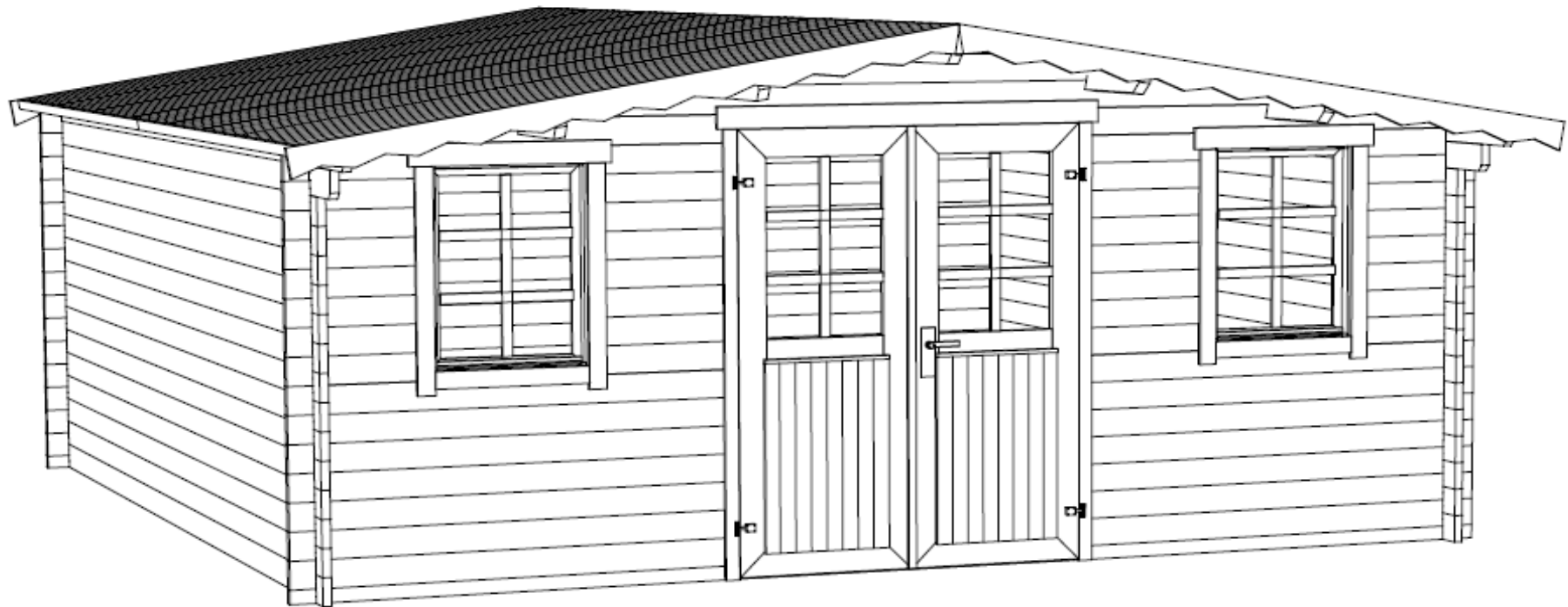

20.01.2014





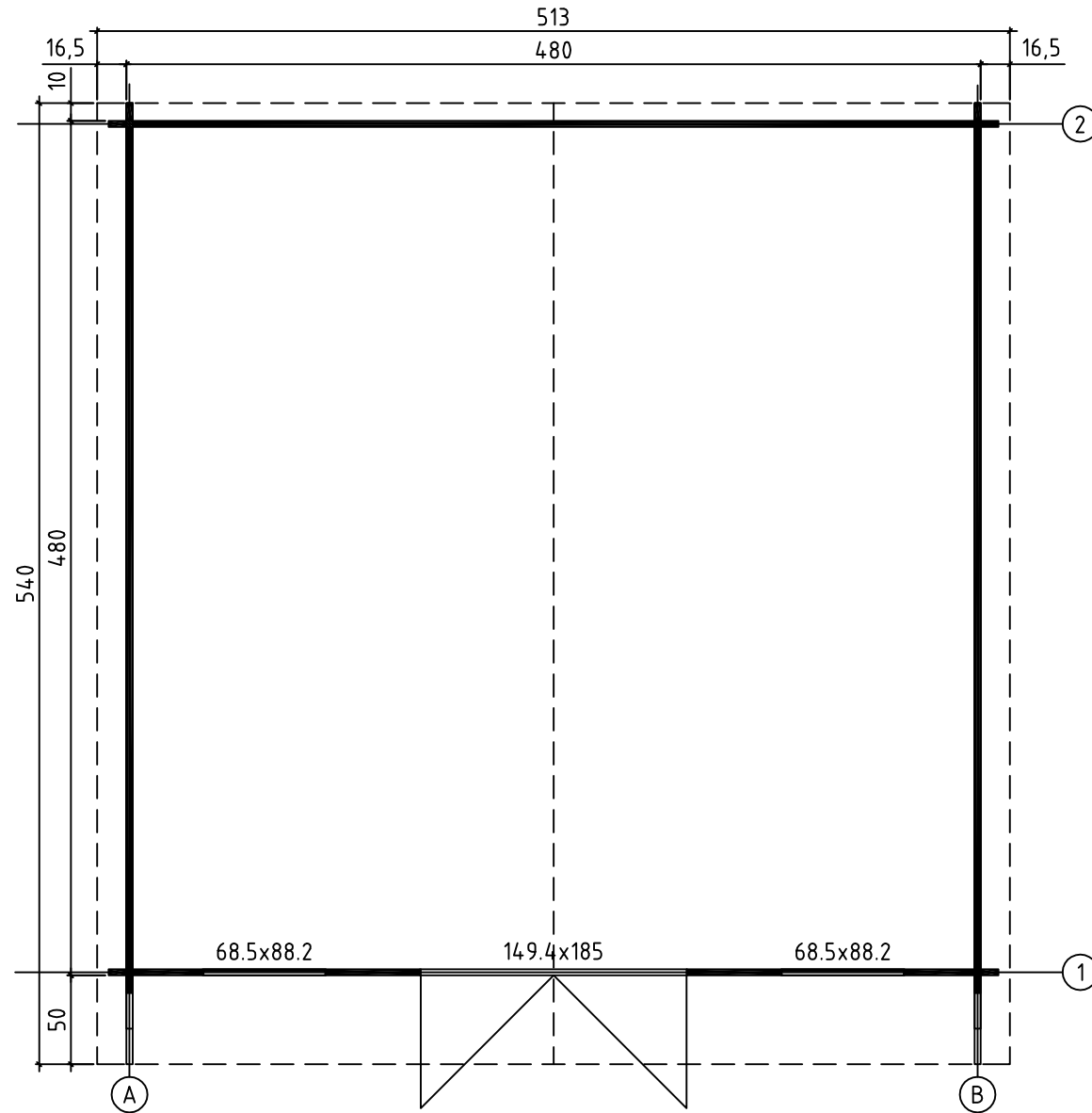



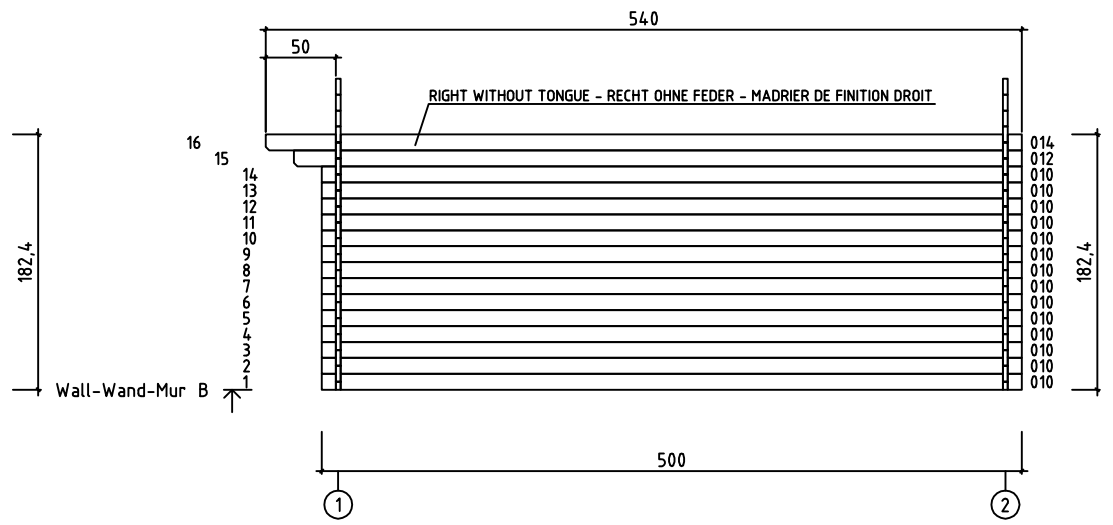
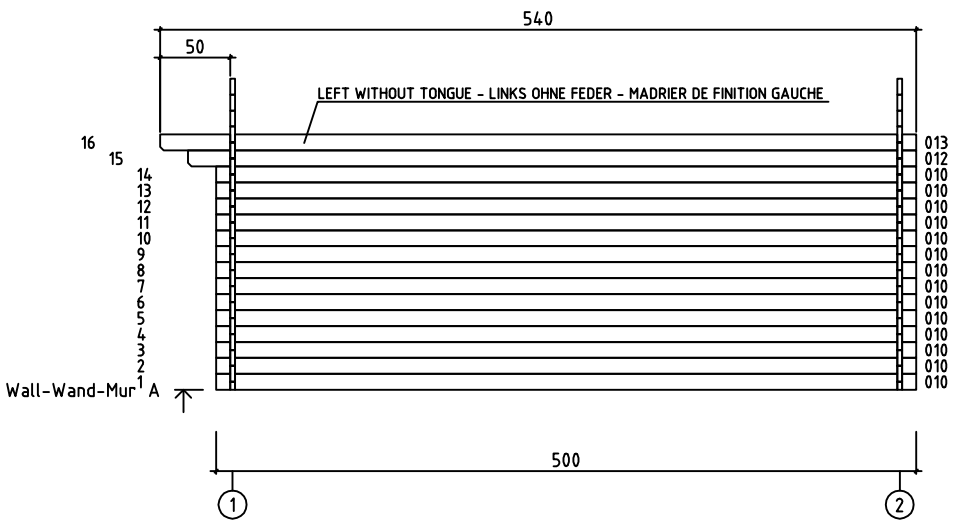
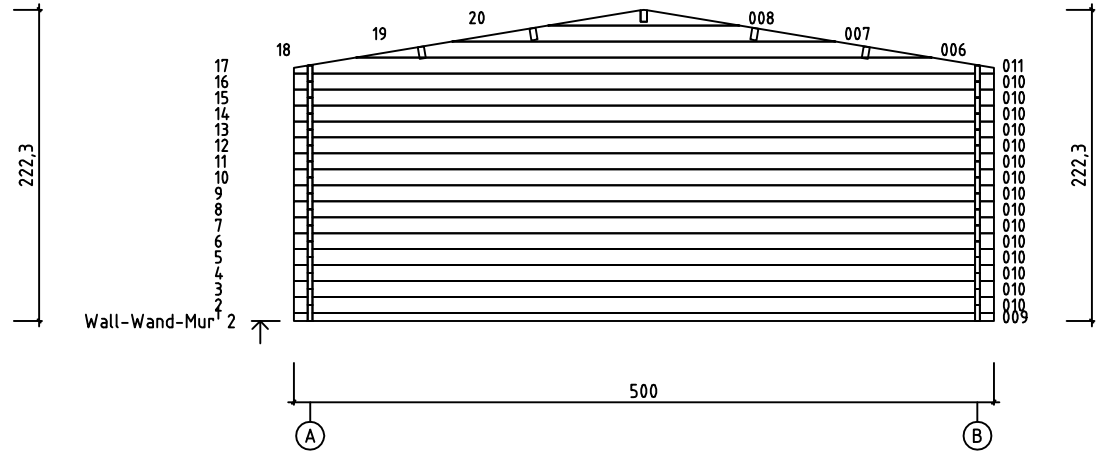
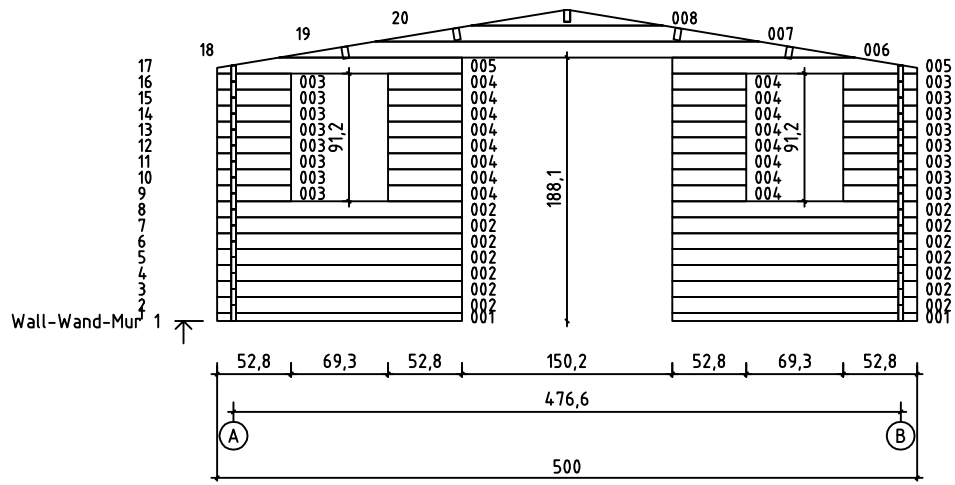

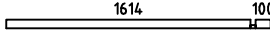
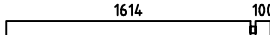

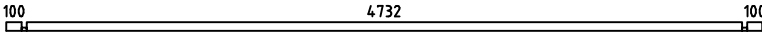
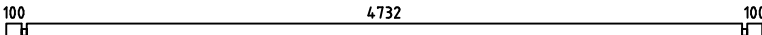
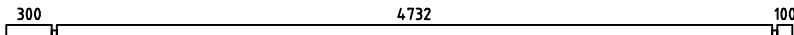
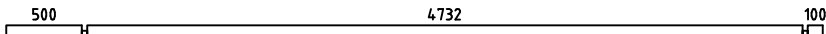
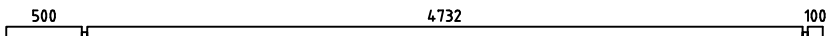
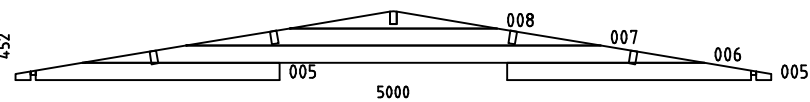
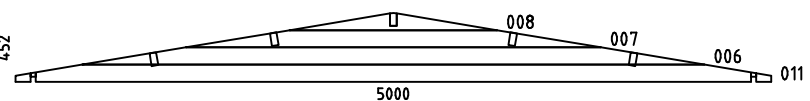
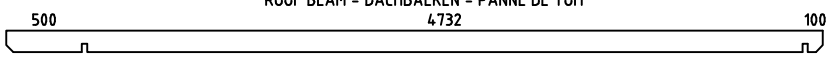
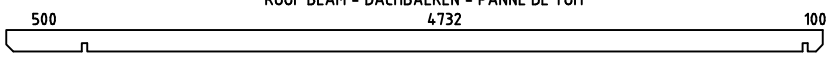
Art.Nr. 345999

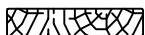

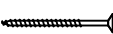



GROUNDPLAN - GRUNDPLAN - PLAN DE MASSE



Art.Nr. 345999

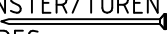

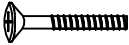
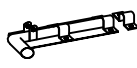
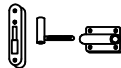
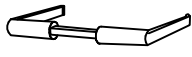
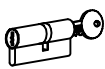
Pos	20.01.2014	Piecelist - Stücklist - Liste des composants Art.Nr. 345999	4/5	Q.	P. (mm)	L. (mm)
001				2	34x57	1748
002				14	34x114	1748
003				16	34x114	528
004				16	34x114	528
009				1	34x57	5000
010				43	34x114	5000
012				2	34x114	5200
013				1	34x120	5400
014				1	34x120	5400
W1-1				1		
W2-1				1		
PR1		ROOF BEAM - DACHBALKEN - PANNE DE TOIT 		1	44x140	5400
A-PR1		ROOF BEAM - DACHBALKEN - PANNE DE TOIT 		4	44x140	5400
		ROOF BOARDS - DACHBRETTER - VOLIGES 		120	90x15	2600
		GABLE MOULDING - GIEBELLEISTE - - PLANCHE DE RIVE 		4	18x120	2650
		EAVES BOARD - TRAUFBRETT - BANDEAU DE TOIT 		4	15x45	2700
		WINDOW HANDLE FITTINGS-FENSTERGRIFF - POIGNÉE D'OUVERTURE DE FENETRE 		2		
HS22		SCREW FOR FIXING DOOR TO THE WALL - SCHRAUBE ZUR BEFESTIGUNG TÜR- ZARGE MIT WAND - VIS DE FIXATION DORMANT DE PORTE 		2	3.5x50	
		SCREW FOR FIXING BOLT HINGE - SCHRAUBE FÜR TÜRRIHEL - - VIS DE FIXATION POUR CHARNIÈRES ET GONDS DE PORTE 		16	4x30	
		SCREW FOR FIXING BOLT HINGE - SCHRAUBE FÜR TÜRRIHEL - - VIS DE FIXATION POUR CHARNIÈRES ET GONDS DE PORTE 		12	4x40	
		SCREW FOR DOOR JAMB - SCHRAUBE FÜR TÜRRAHMEN - VIS DE FIXATION POUR MONTANT DE PORTE 		2	4x60	
		SCREW FOR DOOR JAMB - SCHRAUBE FÜR TÜRRAHMEN - VIS DE FIXATION POUR MONTANT DE PORTE 		2	5x90	
HS59		SCREW FOR DOORSTEP - SCHRAUBEN FÜR SWELLE - VIS DE FIXATION DU SEUIL DE PORTE 		3	3x30	

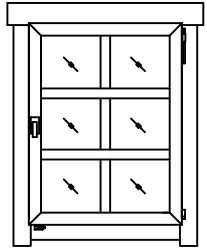
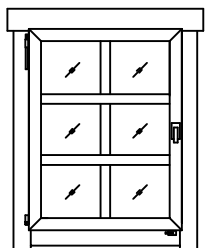
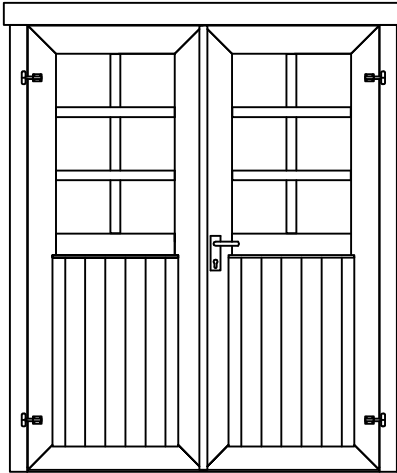
Pos	20.01.2014	Piecelist - Stücklist - Liste des composants Art.Nr. 345999	5/5	Q.	P. (mm)	L. (mm)
		SCREW FOR FILLET - SCHRAUBE ZUR BEFESTIGUNG TÜRLEISTE - - VIS D'ASSEMBLAGE DU CADRE DE PORTE		5	3x30	
		DOOR HANDLE FITTINGS-TÜRGRIF - SET DE GARNITURES DE SERRURE DE PORTE		1		
		NAILS FOR WINDOW/DOOR CROSS SLOT STRAIGHT - NÄGEL FÜR FENSTER/TÜREN EINSENWAREN - POINTE POUR QUINCAILLERIE DE PORTES ET FENETRES		48	1.4x30	
		WINDOW/DOOR CROSS SLOT STRAIGHT (PLASTIC) - FENSTER/TÜREN EINSENWAREN - QUINCAILLERIE POUR PORTES ET FENETRES		24		
		BOLT FOR WINDOW HANDLE FITTINGS - BOLZEN FÜR FENSTERGRIF BESCHLAG - BOULON POUR POIGNÉE D'OUVERTURE DE FENETRE		4		
		LATCH BOLT FÜR DOUBLE DOOR - TORRIEGEL - LOQUET POUR DOUBLE PORTE		2		
		MALE BOLT HINGE FOR DOOR - TÜRRIEGEL - PARTIE MALE DE CHARNIERE DE PORTE		4		
		DOOR HANDLE FITTINGS-TÜRGRIF - GARNITURE DE POIGNÉE DE PORTE		1		
		CYLINDER - ZYLINDERSCHLOSS - CYLINDRE DE SERRURE		1	30/30	
		HAMMER BLOCK - SCHLAGHOLZ - CALLE DE FRAPPE		1		
		WINDOW - FENSTER - FENETRE 685x882 SGA 	AK.1.106.SSP.Pd	1		
		WINDOW - FENSTER - FENETRE 685x882 SGA 	AK.1.106.SSV.Pd	1		
		DOOR - TÜR - PORTE 1494x1850 SGA+GL28 	TUK.2.056.SVP.MXPG34	1		

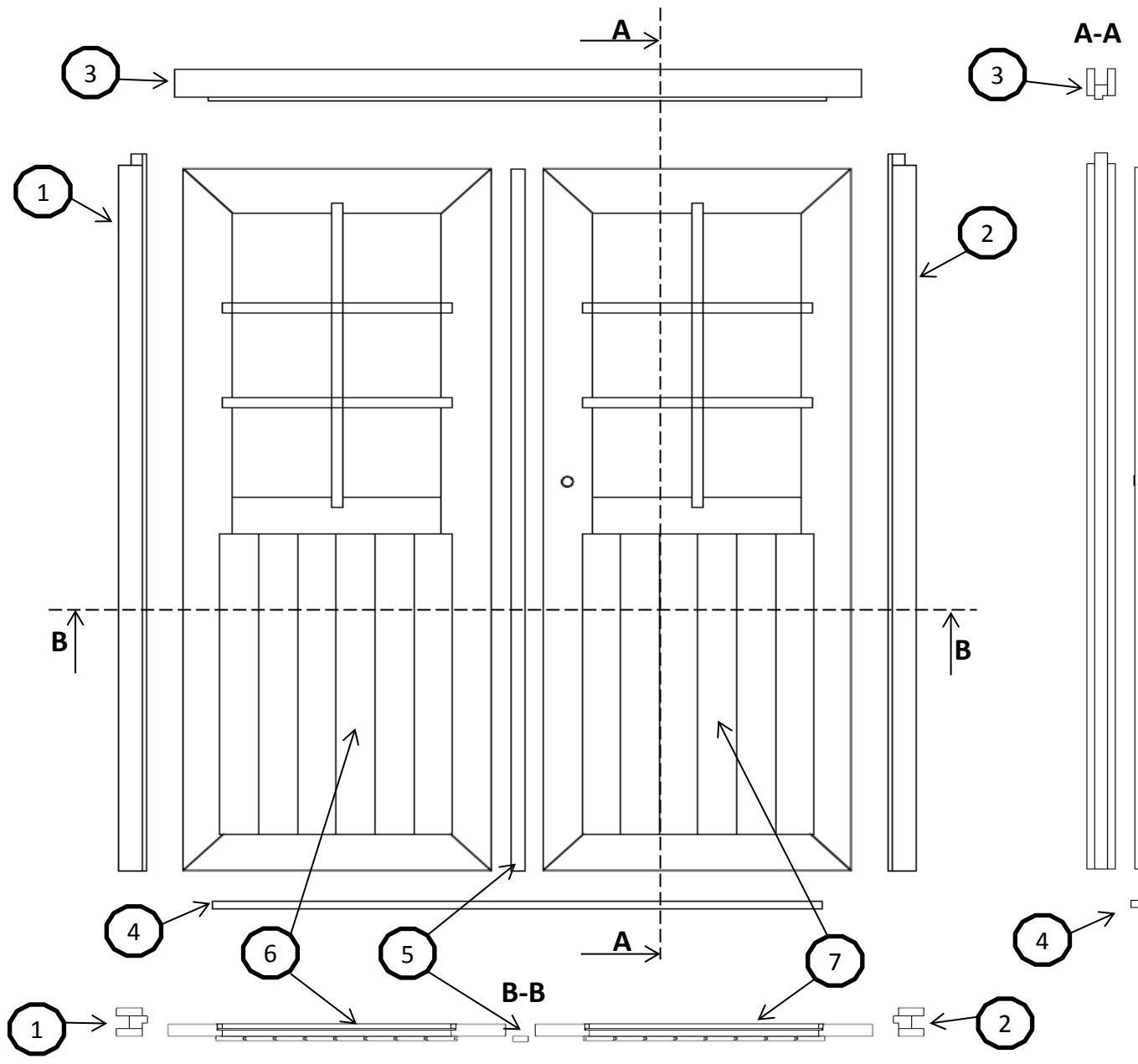

Pos.	Q.	Dimensions
1	1	72 mm, 65 mm
2	1	72 mm, 65 mm
3	1	72 mm, 100 mm
4	1	18 mm, 24 mm
5	1	13 mm, 32 mm
6	1	716 mm
7	1	716 mm

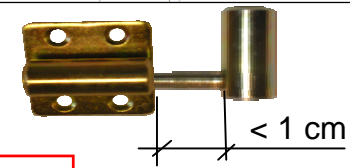
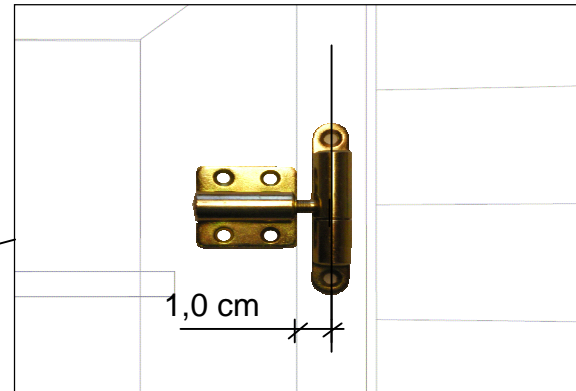
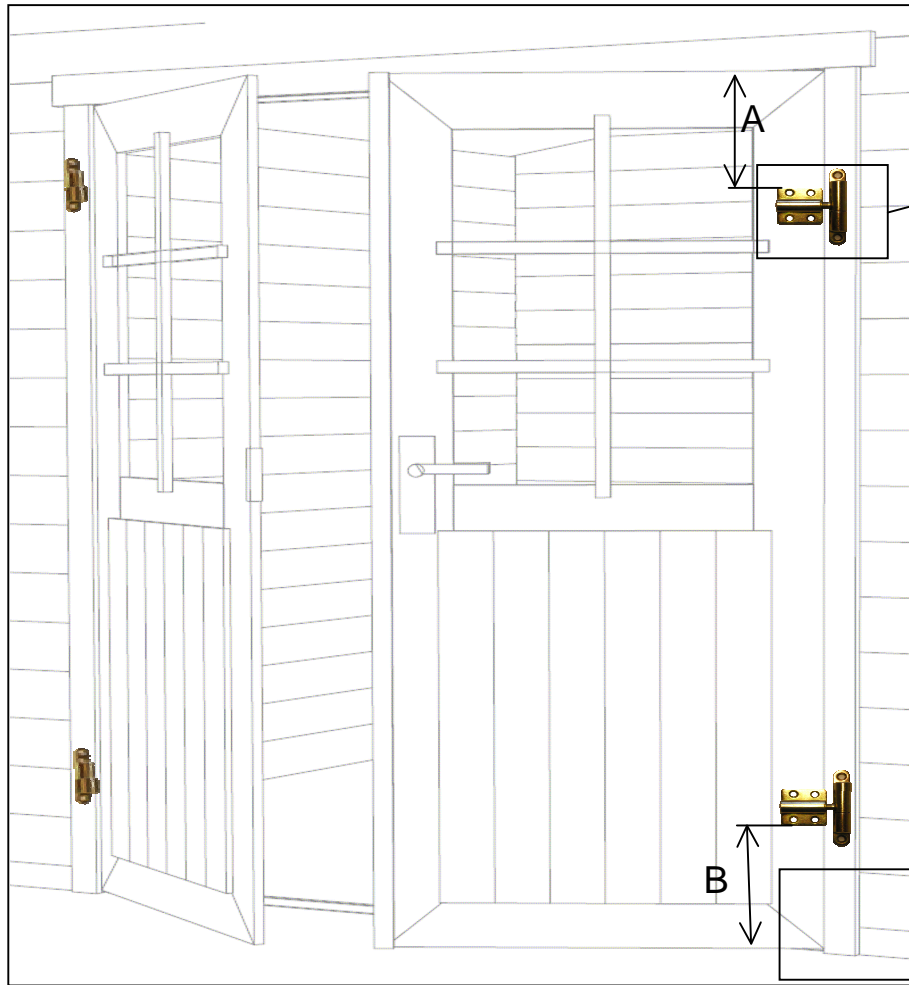

A=B= 210mm

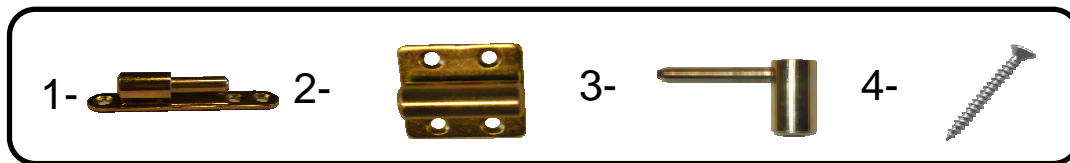
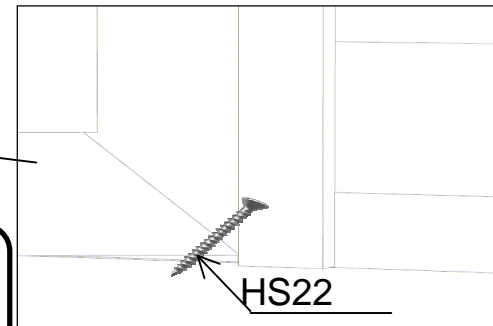

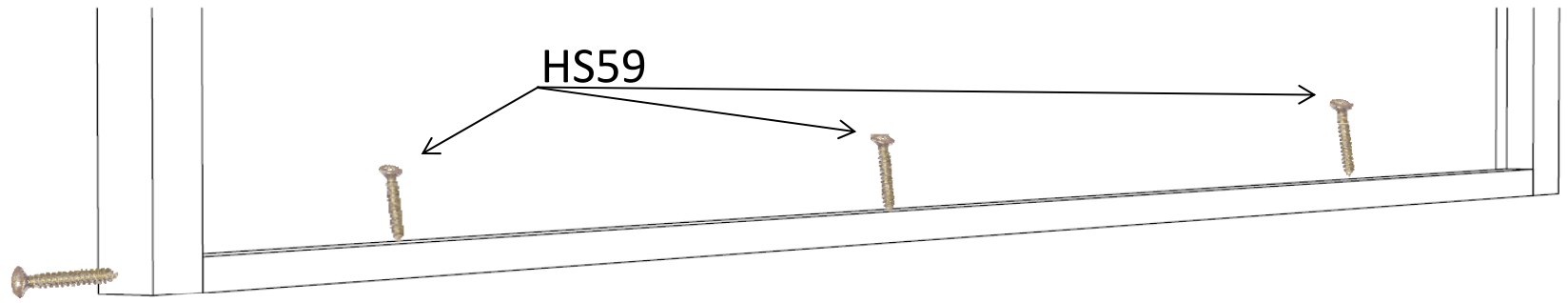



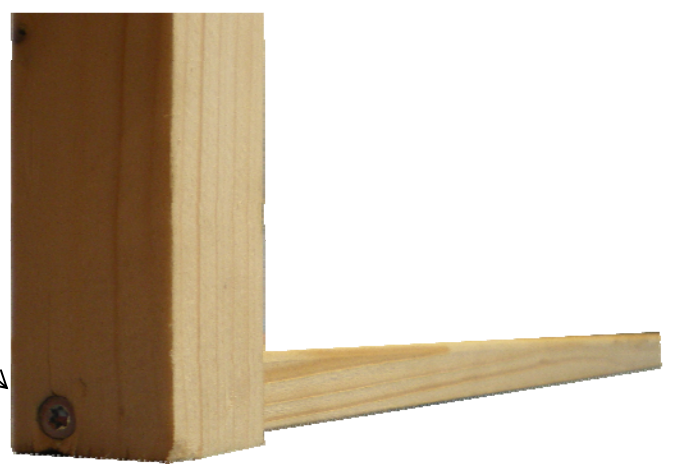

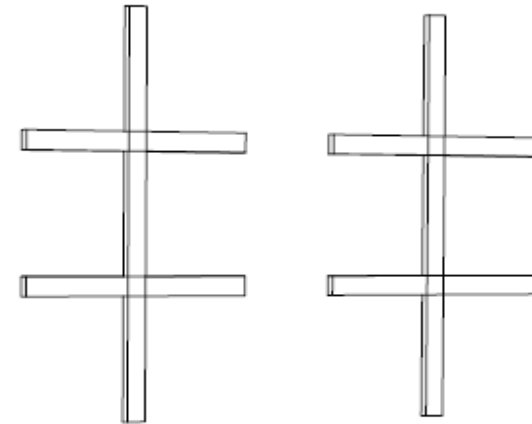
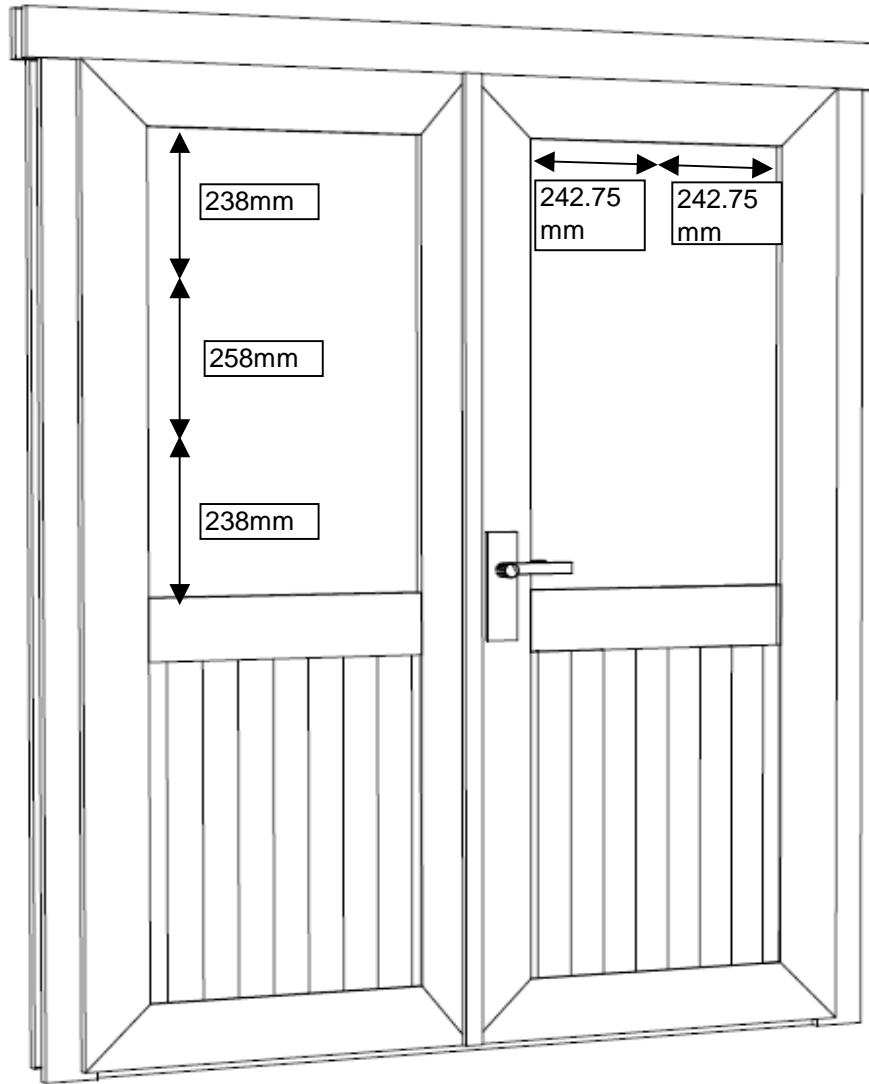
4,0x60mm



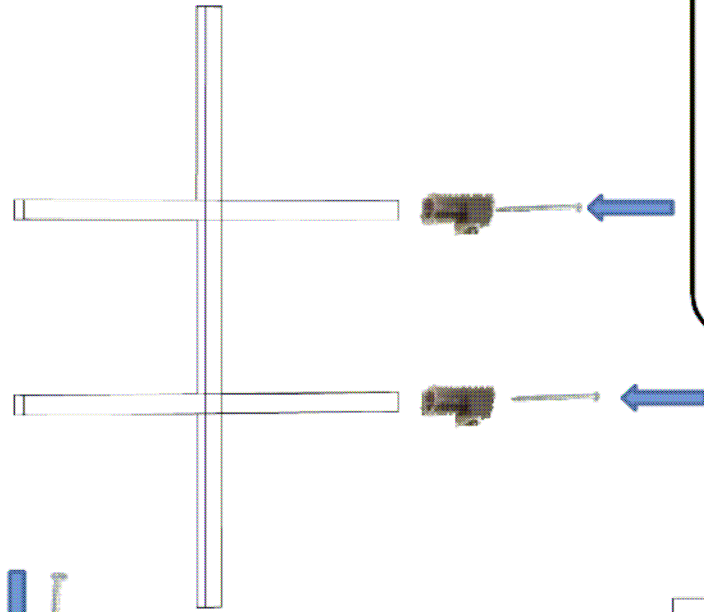
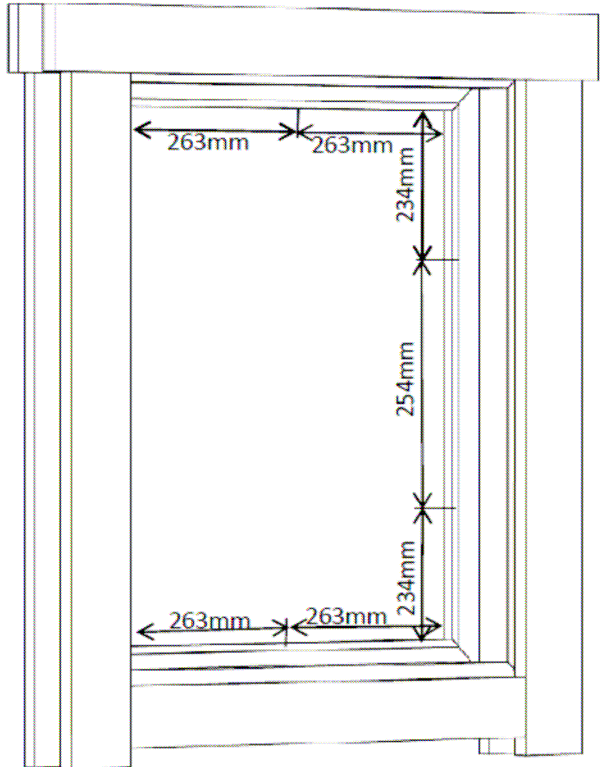

-  - 12pcs
-  - 12pcs
-  - 24pcs

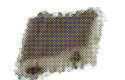
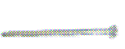

-  -6pcs
-  -6pcs
-  -12pcs

